

Technical Information

- ✓ Rigorously tested to fully comply with EN 15512, EN 15635 and the Australian standard AS 4084
- ✓ Independently certified by world-leading test experts TÜV Nord

How the energy from a vehicle impact is calculated

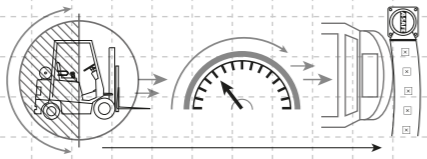

$\frac{1}{2} \text{ Mass} \times \text{Speed}^2 = \text{Joules}$

Tested Impact Energy

1,000 Joules

Equivalent vehicle and speed

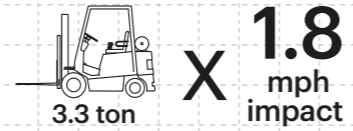

90° Impact on RackGuard

Impact Test

Max Energy (Joules) **1,000**

Deflection at Max Energy
1/8 inch

Material Properties	MEMAPLEX™
Temperature Range	14°F to 122°F
Ignition Temperature	698°F to 734°F
Flash Point	662°F to 698°F
Toxicity	Not Hazardous
Chemical Resistance	Excellent - ISO/TR 10358
Weathering Stability (Grey Scale)	5/5*
Light Stability (Blue Wool Scale)	7/8**
Static Rating (Surface Resistivity)	1015 - 1016 Ω
Hygiene Seals	No

* Weathering scale 1 is very poor and 5 is excellent
** Light stability scale 1 is very poor and 8 is excellent

Racking Profiles

RackGuard Sizes

Description	A-Rack width (max)	B-Rack depth (max)
RackGuard (S) SL	4	1%
RackGuard (S) ML	4	2%
RackGuard (S) LL	4	3%
RackGuard (S) SLR	3%	1%
RackGuard (S) MLR	3%	2%
RackGuard (S) LLR	3%	3%
RackGuard (L) SL	5	3
RackGuard (L) SLR	4%	3

All RackGuards are available in 15%, 23% and 39% inch heights.

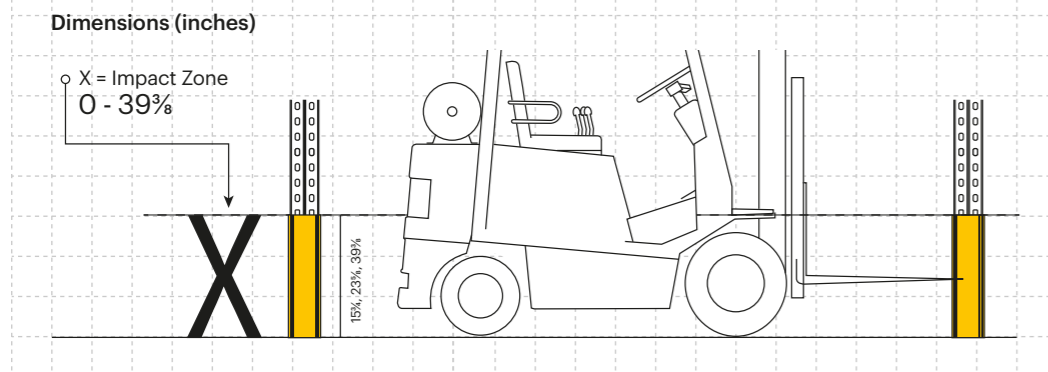

Compression hinges have various widths to fit a range of racking profiles.

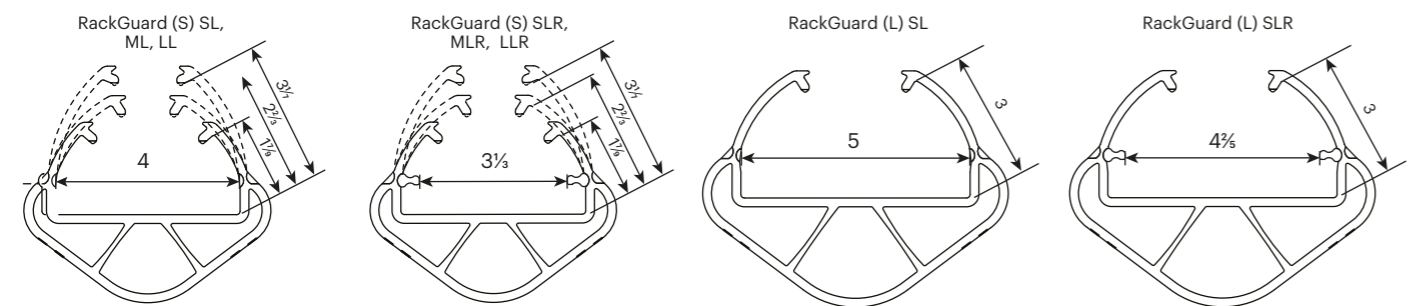

RackGuard Rack Leg Protector



Designed to protect vulnerable rack legs from front, side and scrape impacts by workplace vehicles.

RackGuard protectors absorb and deflect impacts, transferring energy around the rack leg rather than through it, preventing damage to uprights and maintaining the structural integrity of racking systems.

Frictional grip points ensure a secure fit to any sized rack leg.

RackGuard is supplied with a specially developed toolkit for ultra-fast installation.

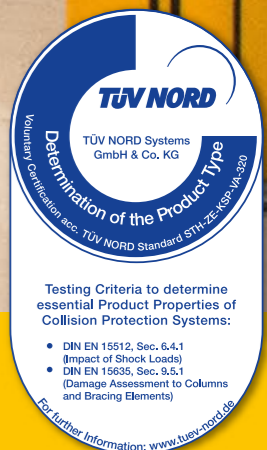

Engineered for performance

State-of-the-art products from A-SAFE are meticulously engineered to deliver the highest performance. Designed, developed, tested and manufactured in-house at our cutting-edge facility, every component is purpose-built to function flawlessly and deliver the ultimate in durability.

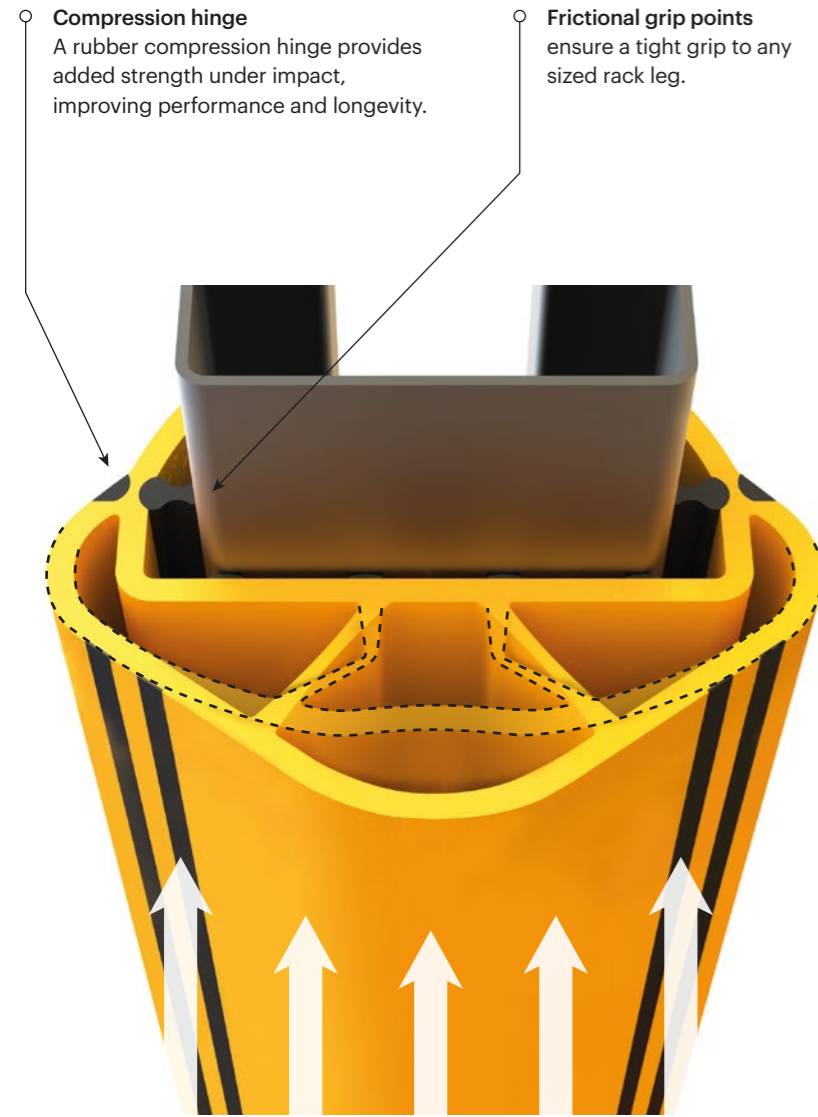

Memaplex™ ultimate strength polymer is an exclusive composition of the most sophisticated polyolefins and rubber additives that have been blended by experts to provide unparalleled strength and flexibility.

Ultra-low maintenance material is chemical and water-resistant, non-corroding, non-scratch and self-colored, so no repainting, rusting, flaking or corrosion.

Huge return on investment through incident prevention and downtime avoidance, thanks to resilient compression features and unique material that can withstand multiple impacts.

Advanced engineering Molecular reorientation during manufacturing creates a unique built-in memory that enables the RackGuard to fully recover following impacts.



Ergonomically designed with a slim profile to limit intrusion into warehouse aisles.

Self colored and UV stabilized for lasting high visibility, without the need for repainting.

Food safe wipe-clean, water-resistant surface.

Eco-friendly and 100% recyclable.

Independently verified performance

RackGuard has been rigorously tested to fully comply with the highest standards for storage equipment, including EN 15512, EN 15635 and the Australian standard AS 4084. Furthermore, testing has been independently verified by TÜV Nord – one of the world's leading independent test organisations – for total peace of mind.

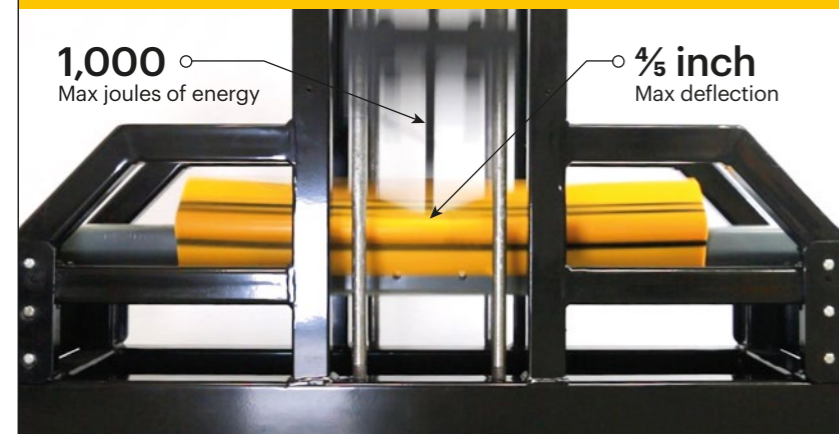

RackGuard is supplied with a specially designed toolkit to ensure it can be installed and removed easily.



RackGuards can also be installed above ground level to protect racks from loading and unloading damage.



Cold Storage option available
Purpose engineered for cold storage temperatures as low as -22°F.
See separate data sheet for details.



Dual branding option
RackGuard can be personalised with your company logo to create a unified branding experience throughout your warehouse facility. Your logo will be prominently printed above the standard A-SAFE logo on every RackGuard.