



RackGuard Rack Leg Protector Cold Storage

The RackGuard Cold Storage Rack Leg Protector is designed to protect vulnerable rack legs from front, side and scrape impacts by workplace vehicles.

It has been purpose-engineered for applications within sub-zero environments such as cold storage facilities. The RackGuard Cold Storage delivers supreme performance in temperatures as low as -30 °C.

RackGuard Cold Storage protectors absorb and deflect impacts, transferring energy around the rack leg rather than through it, preventing damage to uprights and maintaining the structural integrity of racking systems. Frictional grip points ensure a secure fit to any sized rack leg. RackGuard is supplied with specifically developed toolkit for ultra-fast installation.



Ultra-low maintenance material is chemical and water-resistant, non-corroding, non-scratch and self-coloured, so no repainting, rusting, flaking or corrosion.



Huge return on investment from incident prevention and downtime avoidance as barriers, vehicles, floors and equipment do not need replacing or repair.



Rigorously tested to fully comply with EN 15512, EN 15635 and the Australian standard AS 4084



Independently certified by world-leading test experts TÜV Nord



A rubber compression hinge provides added strength under impact, improving performance and longevity.

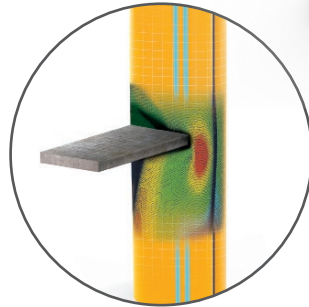

Molecular reorientation during manufacturing creates a unique built-in memory that enables the RackGuard to fully recover following impacts.



Dual branding option RackGuard can be personalised with your company logo to create a unified branding experience throughout your warehouse facility.



RackGuard is supplied with a specially designed toolkit to ensure it can be installed and removed easily.

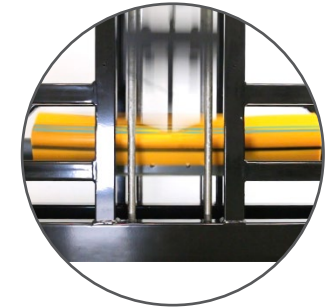

RackGuard has been rigorously tested to fully comply with the highest standards for storage equipment, including EN 15512, EN 15635 and the Australian standard AS 4084. Furthermore, testing has been independently verified by TÜV Nord – one of the world's leading independent test organisations – for total peace of mind.



Standard RackGuards are also available. See separate data sheet for details.

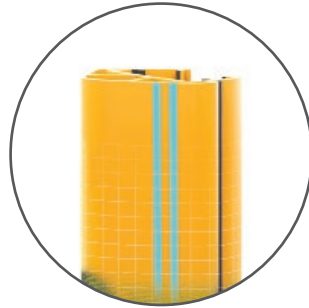

Memaplex™ Sub-Zero has been developed by world-class polymer scientists to deliver maximum performance at sub-zero temperatures. Create from a unique blend of polymers, Memaplex Sub-Zero is designed to withstand impacts without cracking or fragmenting.



Ergonomically designed with a slim profile to limit intrusion into warehouse aisles.



Eco-friendly and 100% recyclable.



RackGuards can also be installed above ground level to protect racks from loading and unloading damage.



Technical Information

How the energy from a vehicle impact is calculated

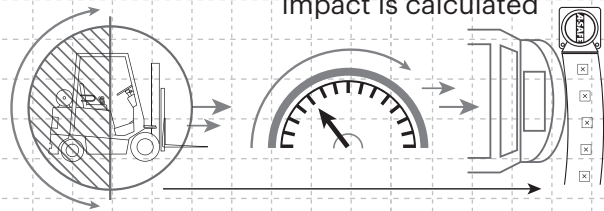

$$\frac{1}{2} \text{ Mass} \times \text{Speed}^2 = \text{Joules}$$

Tested Impact Energy

1,000 Joules

Equivalent vehicle and speed

3 tonne x **1.8 mph** impact
90° Impact on RackGuard

RackGuard Profiles

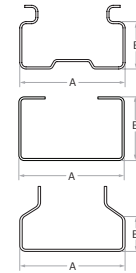

RackGuard Sizes

Description	A-Rack width (max)	B-Rack depth (max)
RackGuard (S) SL	102	44
RackGuard (S) ML	102	68
RackGuard (S) LL	102	80
RackGuard (S) SLR	85	45
RackGuard (S) MLR	85	68
RackGuard (S) LLR	85	80
RackGuard (L) SL	126	75
RackGuard (L) SLR	112	75

All RackGuards are available in 400mm and 600mm heights.

Impact Test

Max Energy (Joules) **1,000**

Deflection at Max Energy
20mm

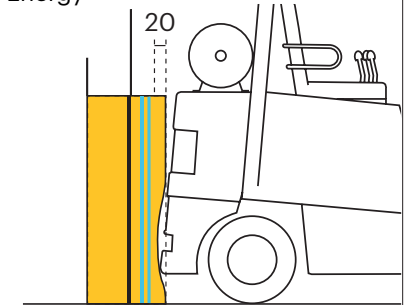

Dimensions (mm)

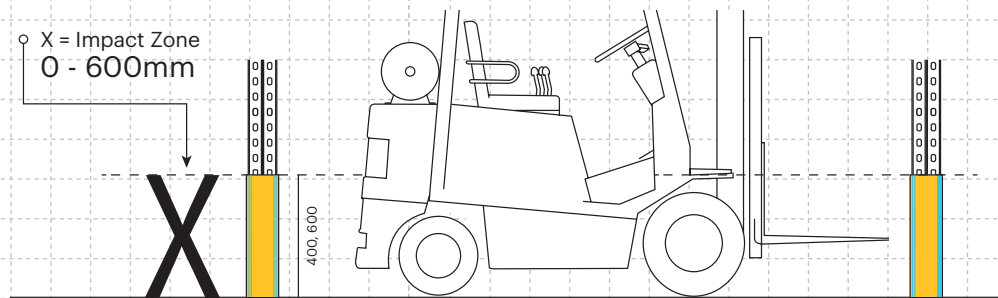

Compression hinges have various widths to fit a range of racking profiles.

RackGuard (S) SL, ML, LL

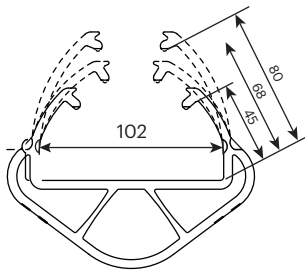

RackGuard (S) SLR, MLR, LLR

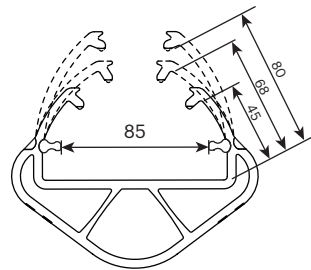

RackGuard (L) SL

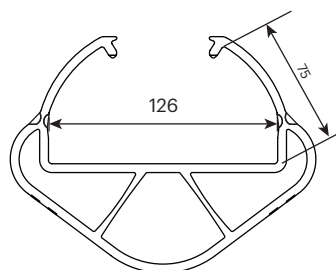

RackGuard (L) SLR

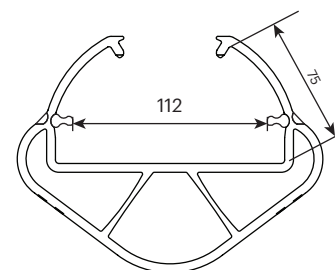

Material Properties

MEMAPLEX™

Temperature Range	-30°C to 0°C
Ignition Temperature	370°C to 390°C
Flash Point	350°C to 370°C
Toxicity	Not Hazardous
Chemical Resistance	Excellent - ISO/TR 10358
Weathering Stability (Grey Scale)	5/5*
Light Stability (Blue Wool Scale)	7/8**
Static Rating (Surface Resistivity)	1015 - 1016 Ω

* Weathering scale 1 is very poor and 5 is excellent

** Light stability scale 1 is very poor and 8 is excellent

A-SAFE UK Ltd

Ainley House, Ainleys Industrial Estate, Elland, Halifax, HX5 9JP, United Kingdom

www.asafe.com

