



## Traffic Gate Installation Guide

**EN**  **WARNING**

Drilling into concrete may create silica dust.  
Silica dust-related diseases may include:

- Lung cancer
- Silicosis
- Chronic obstructive pulmonary disease
- Asthma

Before drilling into concrete, you must assess the risk relating to silica dust.

Silica dust recommended controls:

- Prevent the formation of dust clouds by sufficient water suppression.
- Extract dust at source by using on-tool extraction and H-class industrial vacuum cleaners with high-efficiency particulate HEPA filters.
- If the formation of dust clouds cannot be fully prevented or extracted, use respiratory protective equipment RPE with assigned protective factor APF 20 or above.
- If the formation of dust clouds cannot be fully prevented or extracted, use personal protective equipment PPE to avoid contact with skin and clothes.
- Isolate the work area by sheeting or screening to prevent escaping of dust to the broader environment.
- Clean skin, clothes and tools before leaving the work area to prevent transferring of dust to the broader environment.
- Dispose of dust waste, filters, respiratory protective equipment RPE and personal protective equipment PPE in accordance with federal, state and local regulations.
- In the event of regular exposure, implement a health surveillance program.

**FR** **BE**  **MISE EN GARDE**

Le perçage dans le béton peut générer de la poussière de silice. Les maladies liées à la poussière de silice peuvent inclure :

- le cancer du poumon
- la silicose
- Maladie pulmonaire obstructive chronique
- l'asthme

Avant de percer le béton, vous devez évaluer le risque lié à la poussière de silice.

Les contrôles recommandés pour la poussière de silice :

- Empêcher la formation de nuages de poussière par une suppression suffisante par l'eau
- Extraire la poussière à la source en utilisant des aspirateurs industriels de classe H équipés de filtres HEPA à haute efficacité particulaire.
- Si la formation de nuages de poussière ne peut être entièrement évitée ou extraite, utiliser un équipement de protection respiratoire (EPR) avec un facteur de protection assigné (FPA) de 20 ou plus.
- Si la formation de nuages de poussière ne peut être totalement évitée ou extraite, utiliser un équipement de protection individuelle (EPI) pour éviter tout contact avec la peau et les vêtements.
- Isoler la zone de travail à l'aide d'une bâche ou d'un écran afin d'éviter que les poussières ne s'échappent dans l'environnement en général.
- Nettoyer la peau, les vêtements et les outils avant de quitter la zone de travail afin d'éviter le transfert de poussières dans l'environnement général.
- Éliminer les déchets de poussière, les filtres, l'équipement de protection respiratoire (EPR) et l'équipement de protection individuelle (EPI) conformément aux réglementations européennes, nationales et locales.
- En cas d'exposition régulière, mettre en place un programme de surveillance de la santé.

**NL** **BE**  **WAARSCHUWING**

Bij het boren in beton kan silicastof (kwartsdeeltjes/kwartsstof) vrijkomen. Het inademen van deze stof kan de volgende ziektes veroorzaken:

- Longkanker
- Silicose
- Chronische obstructieve longziekte (COPD)
- Astma

Voordat u in beton boort, moet u het risico tot het creëren van silicastof beoordelen.

- Voorkom de vorming van stofwolken door voldoende wateronderdrukking.
- Zuig stof bij de bron op door gebruik te maken van afzuiging op het gereedschap en industriële stofzuigers van klasse H met zeer efficiënte HEPA-deeltjesfilters.
- Als de vorming van stofwolken niet volledig kan worden voorkomen of afgezogen, gebruik dan ademhalingsbeschermingsmiddelen RPE met toegekende beschermingsfactor APF 20 of hoger.
- Als de vorming van stofwolken niet volledig kan worden voorkomen of afgezogen, gebruik dan persoonlijke beschermingsmiddelen PBM om contact met huid en kleding te vermijden.
- Isoleer het werkgebied door afzetting of afscherming om te voorkomen dat de stof zich verspreid.
- Reinig huid, kleding en gereedschap voordat u het werkgebied verlaat om verspreiding van stof te voorkomen.
- Voer stofafval, filters, ademhalingsbeschermingsmiddelen (RPB's) en persoonlijke beschermingsmiddelen (PBM's) af in overeenstemming met de federale, staats- en lokale voorschriften.
- Voer bij regelmatige blootstelling een programma voor gezondheidstoezicht uit.

**ES**  **AVISO**

La perforación del hormigón puede generar polvo de silice. Las enfermedades relacionadas con ello pueden incluir:

- Cáncer de pulmón
- Silicosis
- Enfermedad pulmonar obstructiva crónica
- Asma

Antes de perforar hormigón, evalúa el riesgo relacionado con el polvo de silice.

Controles recomendados para el polvo de silice:

- Evitar la formación de nubes de polvo mediante la supresión con agua.
- Extraer el polvo en origen mediante la extracción desde la propia herramienta y/o aspiradores industriales de clase H con filtros HEPA de alta eficiencia para partículas.
- Si es inevitable la formación de nubes de polvo o su completa extracción, utilizar equipos de protección respiratoria EPR con factor de protección asignado APF 20 o superior.
- Si es inevitable la formación de nubes de polvo o su completa extracción, utilizar equipos de protección individual EPI para evitar el contacto con la piel y la ropa.
- Aislar la zona de trabajo con láminas o pantallas para evitar la contaminación del entorno con este polvo.
- Limpiar la piel, la ropa y las herramientas antes de abandonar la zona de trabajo para evitar la transferencia de polvo a un entorno más amplio.
- Eliminar los residuos de polvo, los filtros, el equipo de protección respiratoria EPR y el equipo de protección individual EPI de acuerdo con la normativa estatal, regional y local.
- En caso de exposición regular, aplicar un programa de prevención de riesgos laborales y control sanitario.

**IT**  **ATTENZIONE**

La perforazione nel calcestruzzo può creare polvere di silice. Le malattie legate alla polvere di silice possono includere:

- Cancro ai polmoni
- Silicosi
- Broncopneumopatia cronica ostruttiva
- Asma

Prima di forare il calcestruzzo è necessario valutare il rischio relativo alla polvere di silice.

Le precauzioni consigliate per la polvere di silice sono:

- Prevenire la formazione di nubi di polvere attraverso l'uso di acqua.
- Aspirare la polvere alla fonte utilizzando un utensile come gli aspiratori industriali classe H con filtri HEPA anti-particolato ad alta efficienza.
- Se la formazione di nuvole di polvere non può essere completamente prevenuta o la polvere non può essere estratta, utilizzare dispositivi di protezione delle vie respiratorie RPE con fattore di protezione assegnato APF 20 o superiore.
- Se la formazione di nuvole di polvere non può essere completamente prevenuta o se la polvere non può essere estratta, utilizzare i dispositivi di protezione individuale DPI per evitare il contatto con la pelle e gli indumenti.
- Isolare l'area di lavoro con teli o schermature per impedire la fuoriuscita e diffusione di polvere nell'ambiente.
- Pulirsi e lavare vestiti e strumenti prima di lasciare l'area di lavoro per evitare il trasferimento di polvere nell'ambiente.
- Smaltire rifiuti di polvere, filtri, dispositivi di protezione respiratoria RPE e dispositivi di protezione individuale DPI in conformità con le normative statali e locali.
- In caso di esposizione regolare, attivare un programma di sorveglianza sanitaria.

**DK**  **ADVARSEL**

Under boring i beton, kan der opstå silicestøv. Silicestøv kan forårsage følgende sygdomme:

- Lungekræft
- Silikose / støvlunger
- Kronisk Obstruktiv Lungesygdom (KOL)
- Astma

Før du borer i beton, skal du vurdere risikoen ved silicestøv.

Anbefalede tiltag for at minimere silicestøv:

- Undgå dannelsen af støvskyer ved brug af et tilstrækkelig vandtryk.
- Brug udsugning på værktøjet og H-klasse industrielle støvsugere med højeffektive HEPA-partikelfiltre.
- Hvis dannelsen af støvskyer ikke kan forhindres eller fjernes, skal du bruge et åndedrætsværn (RPE) med tildelt beskyttelsesfaktor APF 20 eller derover.
- Hvis dannelsen af støvskyer ikke helt kan forhindres eller fjernes, skal du bruge personlige værnemidler PPE for at undgå kontakt med hud og tøj.
- Isolér arbejdsområdet ved at dække eller afskærme det, så du forhindrer udslip til det omgivende miljø.
- Rengør hud, tøj og værktøj, før du forlader arbejdsområdet for at forhindre overførsel af støv til det omgivende miljø.
- Bortskaf støvaffald, filtre, åndedrætsværn RPE og personlige værnemidler PPE i overensstemmelse med føderale, statslige og lokale bestemmelser.
- I tilfælde af regelmæssig eksponering, implementer et sundhedsovervågningsprogram.

**DE**  **WARNUNG**

Beim Bohren in Beton kann Silikastaub entstehen.

Zu den durch Siliziumdioxidstaub verursachten Krankheiten können gehören:

- Lungenkrebs
- Silikose
- Chronisch obstruktive Lungenerkrankung
- Asthma

Bevor Sie in Beton bohren, müssen Sie das Risiko in Bezug auf Quarzstaub abschätzen.

Empfohlene Kontrollen für Silikastaub:

- Verhindern Sie die Bildung von Staubwolken durch ausreichende Wasserunterdrückung.
- Saugen Sie den Staub an der Quelle ab, indem Sie am Werkzeug zur Absaugung den Industriestaubsauger der Klasse H mit hochwirksamen HEPA Partikelfiltern verwenden.
- Wenn die Bildung von Staubwolken nicht vollständig verhindert oder abgesaugt werden kann, ist ein Atemschutzgerät RPE mit einem zugewiesenen Schutzfaktor APF 20 oder höher zu verwenden.
- Wenn die Bildung von Staubwolken nicht vollständig verhindert oder abgesaugt werden kann, ist eine persönliche Schutzkleidung (PSA) zu verwenden, um den Kontakt mit Haut und Kleidung zu vermeiden.
- Isolieren Sie den Arbeitsbereich durch Abdeckungen oder Abschirmungen, um das Entweichen von Staub in die Umgebung zu verhindern.
- Reinigen Sie Ihre Haut, Kleidung und Werkzeuge bevor Sie den Arbeitsbereich verlassen, um die Übertragung von Staub in weitere Umgebungen zu verhindern.
- Entsorgen Sie Staubabfälle, Filter, Atemschutzgeräte RPE und persönliche Schutzkleidung PPE in Übereinstimmung mit den bundes-, landes-, und ortsrechtlichen Vorschriften.
- Bei regelmäßiger Belastung ist ein Gesundheitsschutzprogramm durchzuführen.

**PL**  **OSTRZEŻENIE**

Wiercenie w betonie może powodować powstawanie pyłu krzemionkowego.

Choroby związane z pyłem krzemionkowym mogą obejmować:

- Rak płuc
- Krzemica
- Przewlekła obturacyjna choroba płuc
- astma

Przed wierceniem w betonie należy ocenić ryzyko związane z pyłem krzemionki.

Zalecane środki zapobiegawcze związane z pyłem krzemionki:

- Należy zapobiegać tworzeniu się chmur pyłu poprzez wystarczające tłumienie wody.
- Należy usuwać pył u źródła, stosując odciąganie przy użyciu narzędzi oraz odkurzacze przemysłowe klasy H z wysokosprawnymi filrami cząstek stałych HEPA.
- Jeśli nie można w pełni zapobiec powstawaniu chmur pyłu lub go odessać, należy stosować sprzęt ochrony dróg oddechowych RPE z współczynnikiem ochrony APF 20 lub wyższym.
- Jeśli nie można w pełni zapobiec tworzeniu się chmur pyłu lub nie można go odsysać, należy stosować środki ochrony indywidualnej PPE, aby uniknąć kontaktu ze skórą i ubraniem.
- Należy odizolować miejsce pracy za pomocą płachty lub ekranu, aby zapobiec wydostawaniu się pyłu do szerszego otoczenia.
- Należy oczyścić skórę, odzież i narzędzia przed opuszczeniem miejsca pracy, aby zapobiec przenoszeniu pyłu do szerszego środowiska.
- Należy usuwać odpady pyłu, filtry, sprzęt ochrony dróg oddechowych RPE i sprzęt ochrony osobistej PPE zgodnie z lokalnymi przepisami.
- W przypadku regularnego narażenia, wdrożyć program kontroli zdrowia.



コンクリートへの穴開け作業時には粉じんが発生することがあり、健康被害の可能性があります。

- ・肺がん
- ・珪肺
- ・慢性閉塞性肺疾患
- ・気管支喘息

#### 推奨される対策

- ・散水・噴霧により、粉じんの飛散を防止する。
- ・集じん機や高面積のHEPAフィルター搭載のバキュームクリーナーで、発生源から粉じんを除去する。
- ・粉じんの発生を完全に防止または除去できない場合は、防護係数（APF）20以上の呼吸用保護具を使用する。
- ・粉じんの発生を完全に防止または除去できない場合は、個人用防護具(PPE)を使用し、皮膚や衣服への接触を避ける。
- ・粉じんが広範囲に漏れないように、シートや遮蔽物によって作業場を隔離する。
- ・作業場から離れる前に、皮膚、衣服、道具をきれいにし、粉じんが広範囲に移行するのを防ぐ。
- ・粉じん、フィルター、呼吸用保護具(RPE)および個人用防護具(PPE)は、国、都道府県および市町村の規制に従って処理する。
- ・定期的なばく露がある場合は、健康診断、保健指導を実施する。

# A

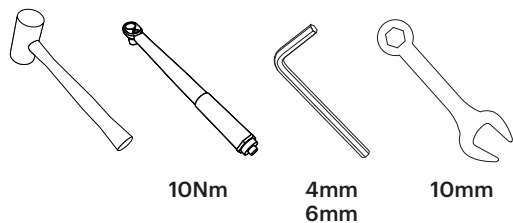

10Nm

4mm  
6mm

10mm

- 1 Lower Rail x1
- 2 Rail Pin x1
- 3 2m / 2.5m = x6 Threaded Insert (PACK 1)  
3m = x9 Threaded Insert (PACK 1 & PACK 5)
- 4 Rail Pin Cap x2
- 5 Mounting Bracket x1 (PACK 1)
- 6 Bracket Block x1 (PACK 1)
- 7 M6 x 25 Button Head Screw Flanged x2 (PACK 1)
- 8 M6 Nyloc Hex Nut - Flanged x2 (PACK 1)
- 9 2 / 2.5m = Handle Spacer x6 (PACK 1)  
3m = Handle Spacer x9 (PACK 1 & PACK 5)
- 10 2m / 2.5m = x6 M6 x 70 Screw (PACK 1)  
3m = x9 M6 x 70 Screw (PACK 1 & PACK 5)
- 11 Coupling x1
- 12 2m / 2.5m = x2 Handles  
3m = x3 Handles

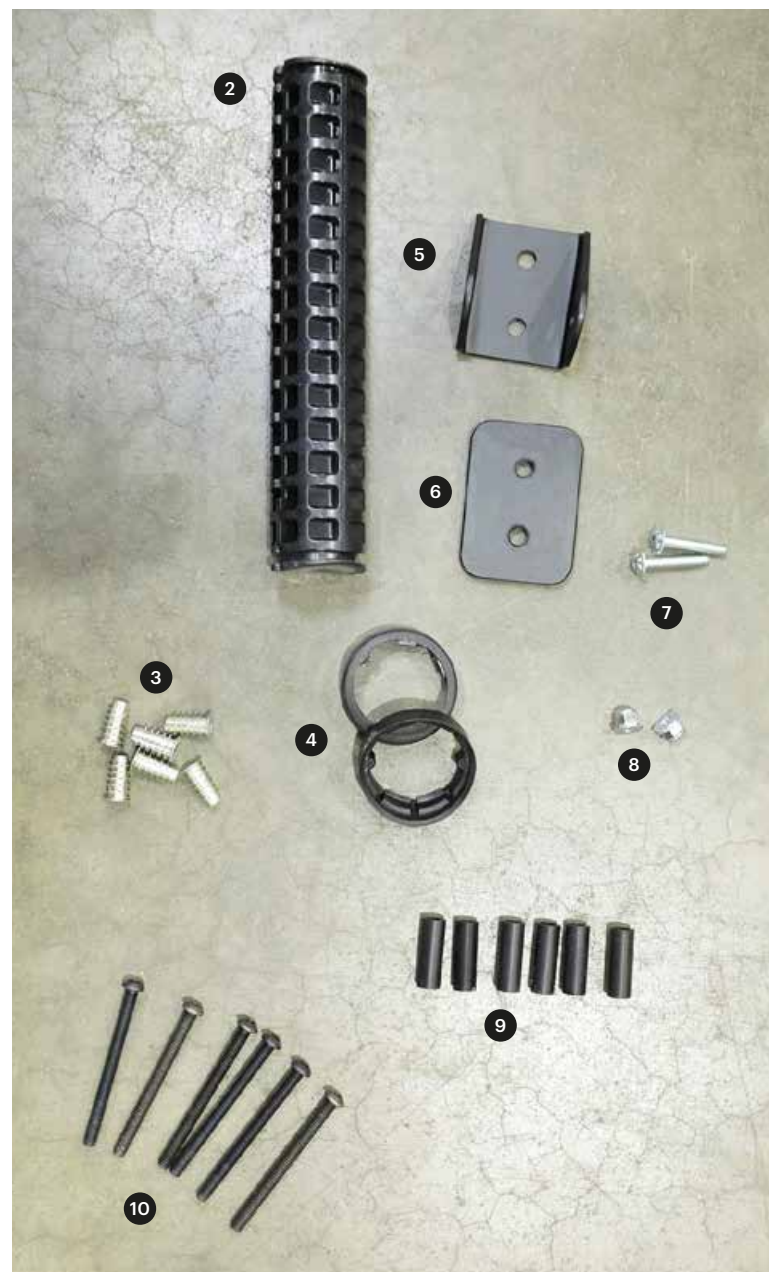

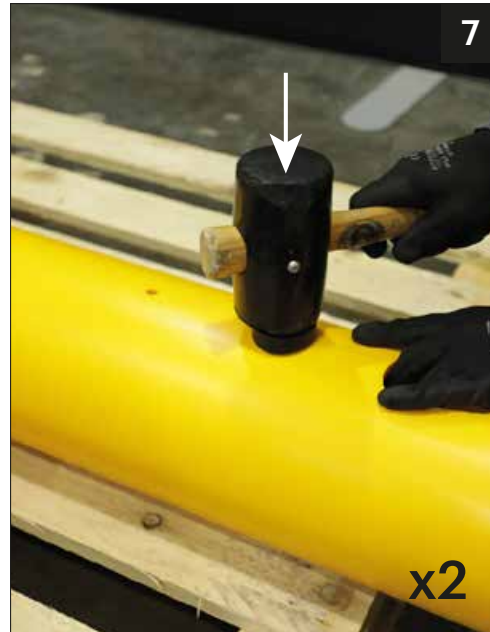
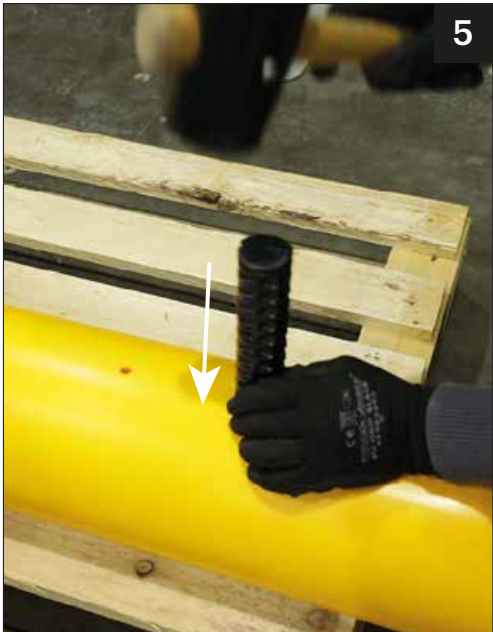
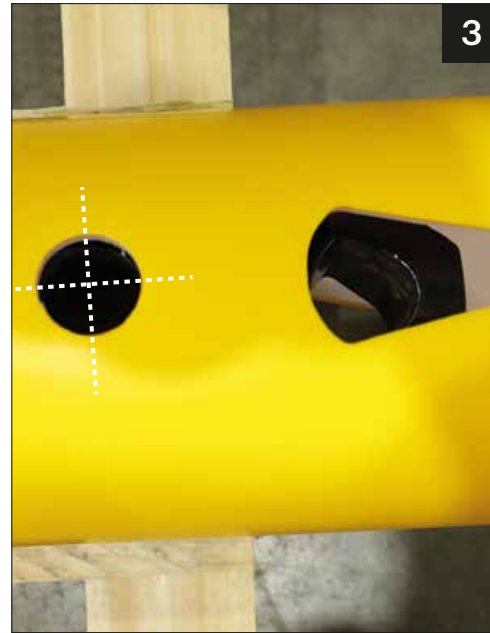

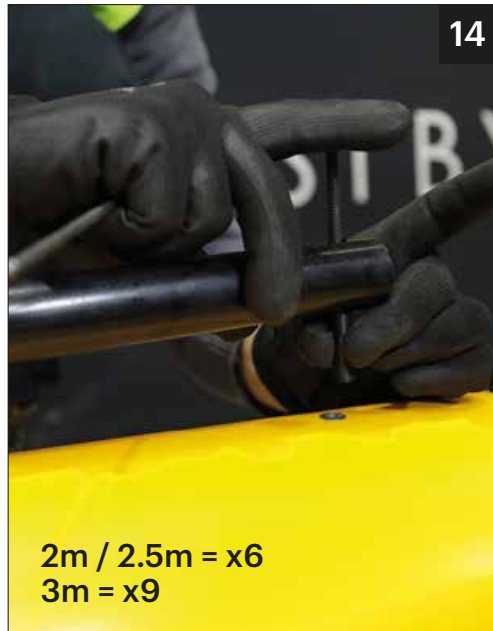

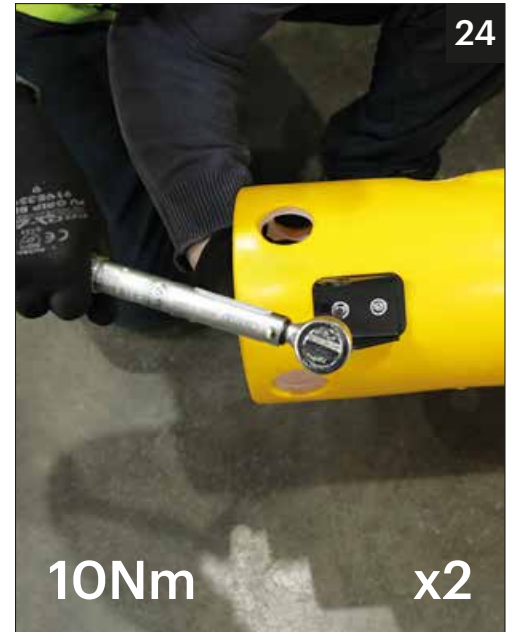



# B

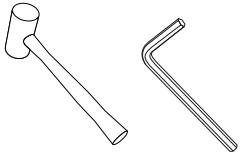

5mm

- 1 Stabiliser x2 (PACK 1)
- 2 M6 Hex Nut x1 (PACK 1)
- 3 M6 x 150 Screw (PACK 1)
- 4 Upper Rail x1

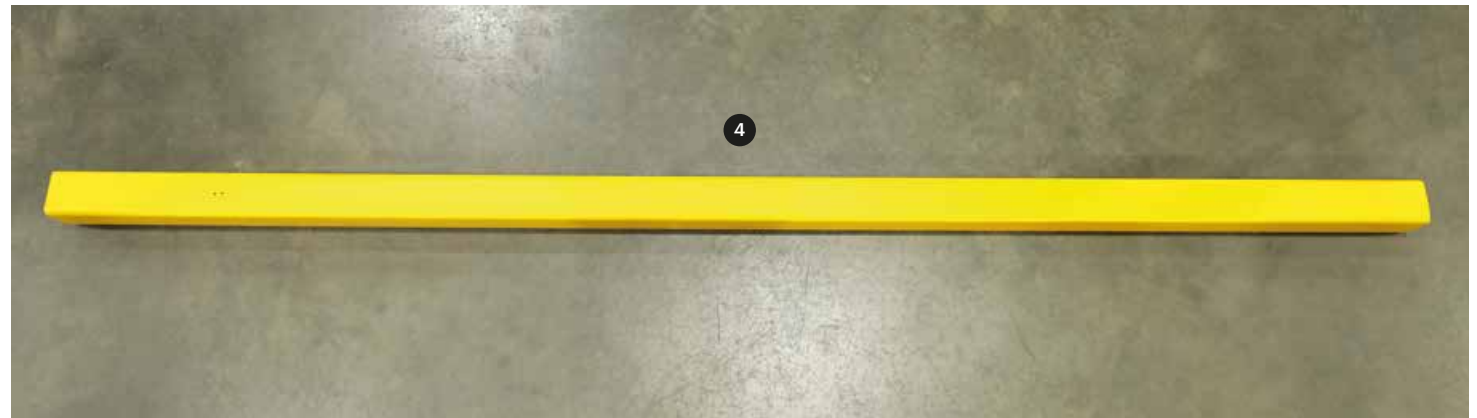

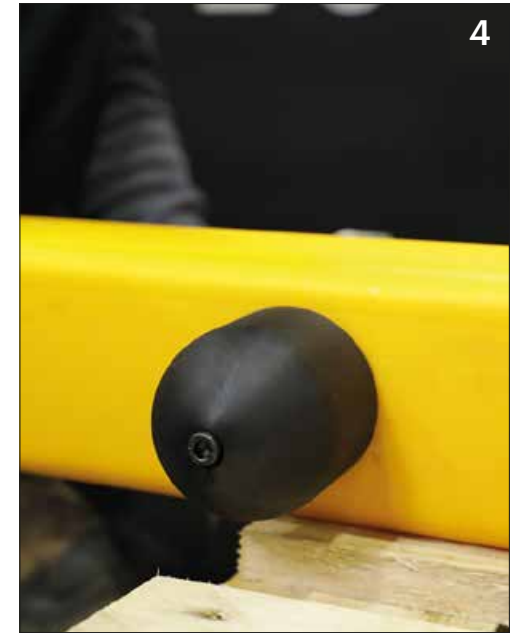

# C

- 1 Hitch Post x2
- 2 Lock Pin Assembly x1
- 3 Post Pin x2
- 4 Post Pin Plate x4
- 5 Buffer Pad x1 (PACK 3)







# D

- 1 RH Post x1
- 2 Spring Shaft x1 (PACK 2)
- 3 M12 Washer x1 (PACK 2)
- 4 Spring x1 (PACK 2)
- 5 Spring Stop x1 (PACK 2)
- 6 'R' Clip (PACK 2)
- 7 Ball Knob (PACK 2)

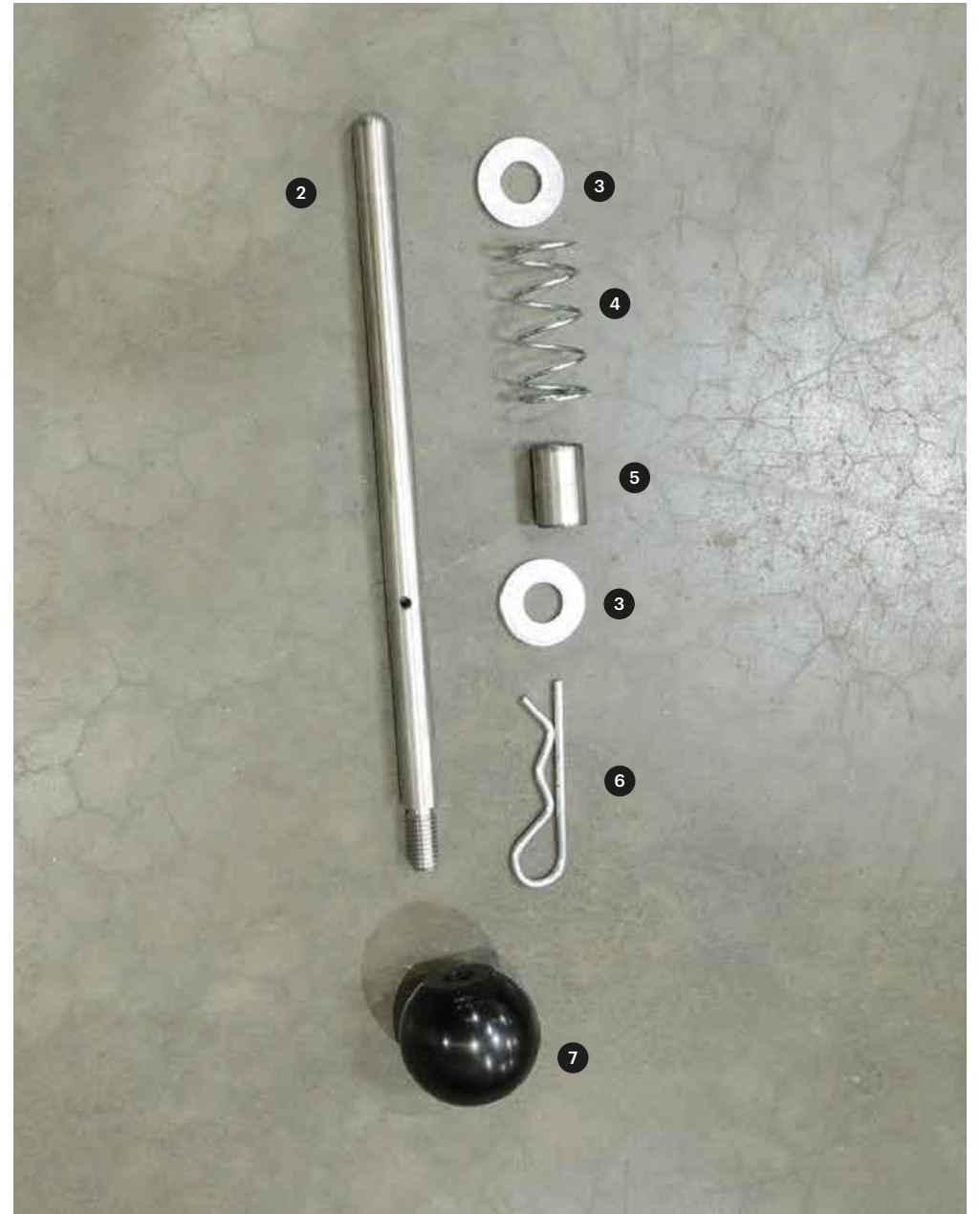

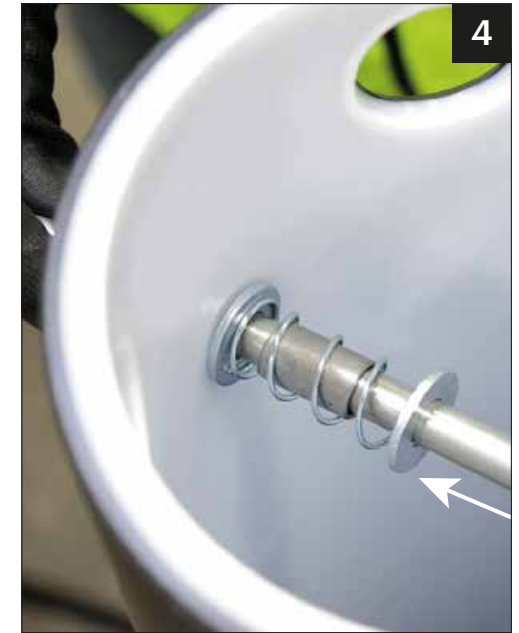
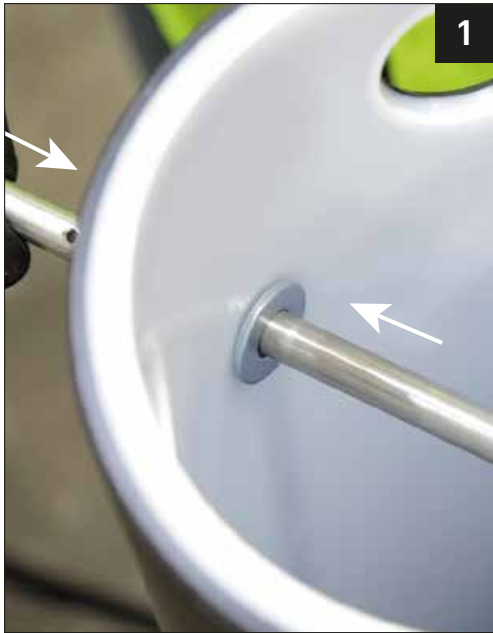

# E

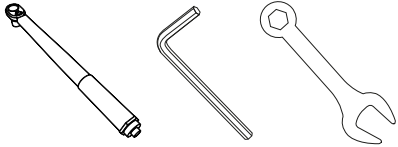

30Nm

6mm

17mm

- 1 Post x2 - LH & RH
- 2 Hitch Post Assembly x 1
- 3 Rail Bracket x1
- 4 Axle Collar x2 (PACK 2)
- 5 Rail Axle x1
- 6 Buffer Pad (PACK 3)
- 7 M10 Nyloc Nuts x4 (PACK 2)
- 8 M10 Washers x4 (PACK 2)
- 9 M10 x 50 Screw x4 (PACK 2)
- 10 Lower Rail and Handles x 1









# F

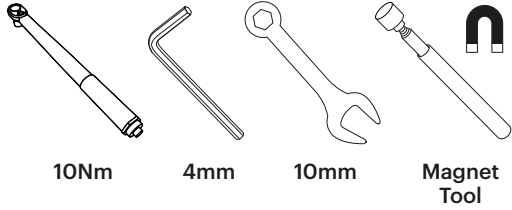

- 1 Connector Bar x1
- 2 Back Plate (PACK 3)
- 3 M6 Nyloc Hex Nut - Flanged x2 (PACK 3)
- 4 M6 Hex Nut (PACK 3)
- 5 M6 Dome Nut x2 (PACK 3)
- 6 Connector Bar Bracket x2 (PACK 3)
- 7 M6 x 25 Button Head Screw with Lock Patch x4 (PACK 3)
- 8 M6 x 25 Shoulder Bolt x2 (PACK 3)

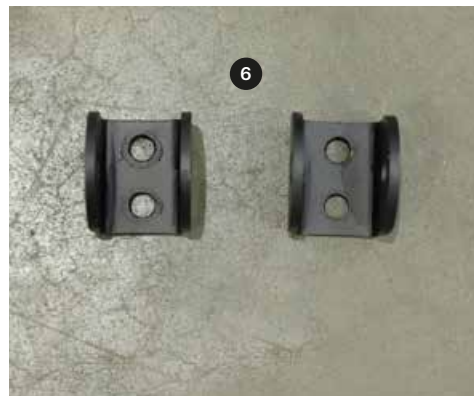

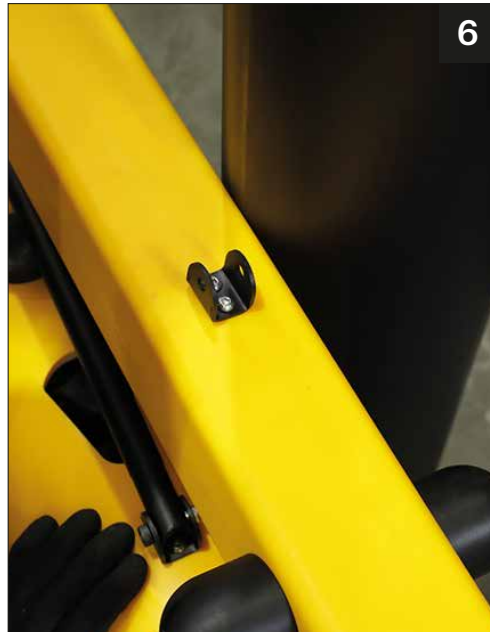

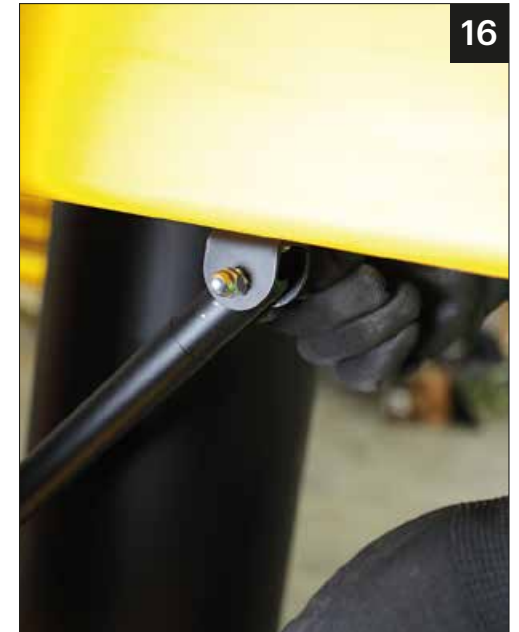
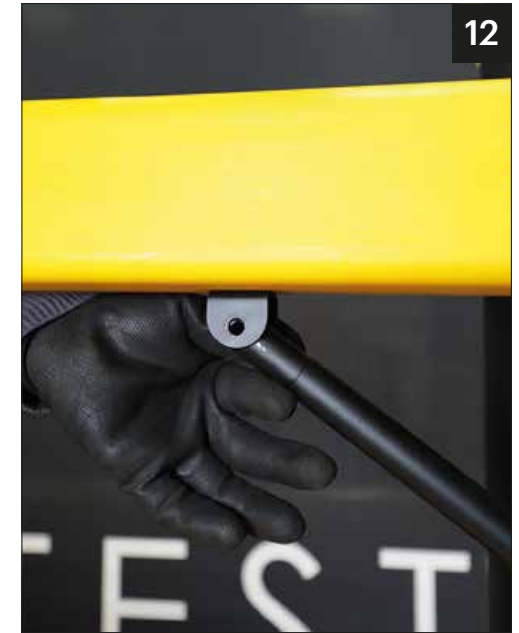

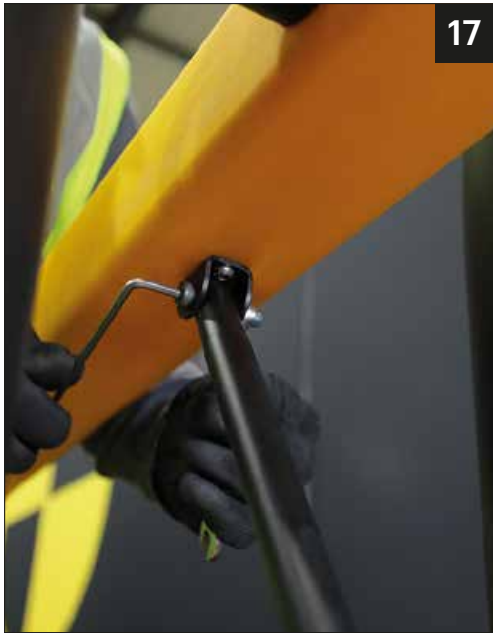

# G

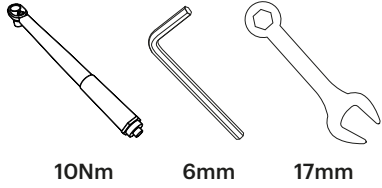

### All items from Pack 3

- ① M10 x 100 Shoulder Bolt x1
- ② M10 Hex Nut x1
- ③ M10 Dome Nut x1
- ④ Top Rail End Cap x2



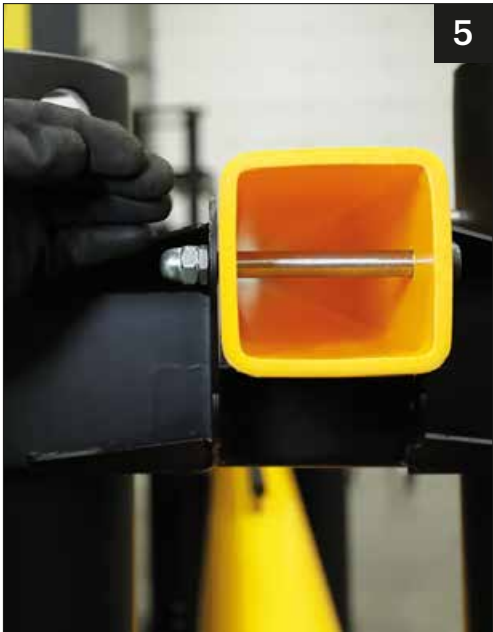





# H

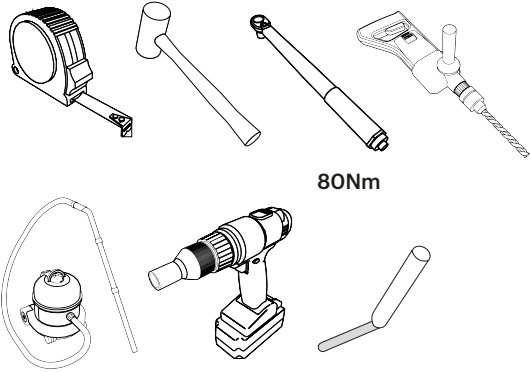

80Nm

1 Ground Fixing x8





# I

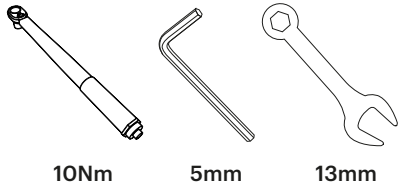

- 1 Gas Strut x1
- 2 M8 x 100 Shoulder Bolt x1 (PACK 4)
- 3 Large Spacer x2 (PACK 4)
- 4 M8 Dome Nut x2 (PACK 4)
- 5 M8 Hex Nut x2 (PACK 4)
- 6 M8 x 50 Shoulder Bolt x1 (PACK 4)
- 7 Small Spacer x2 (PACK 4)



## Gas strut forces

Gate Size	Force
2.0m (6.5ft)	1250N
2.5m (8ft)	1435N
3m (10ft)	1600N

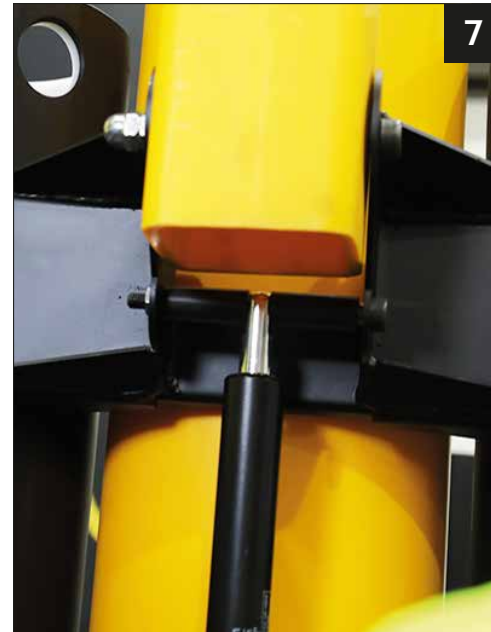

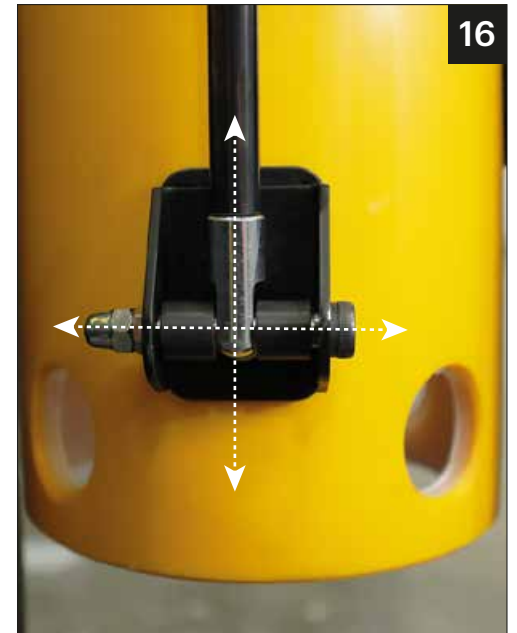
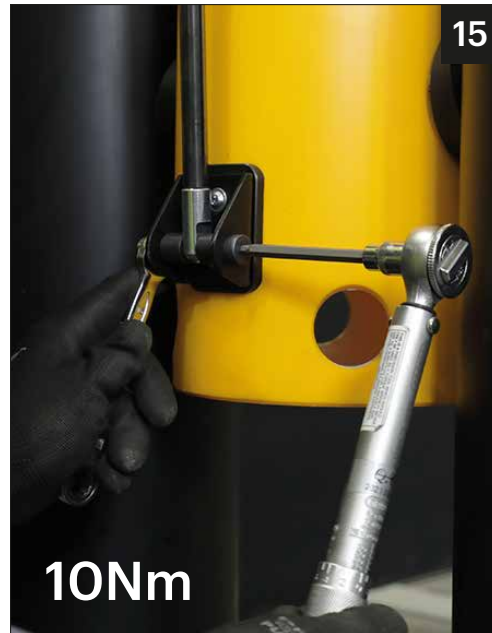
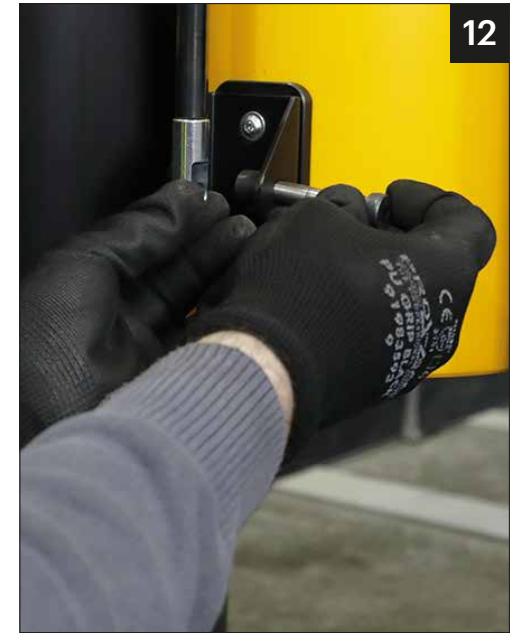
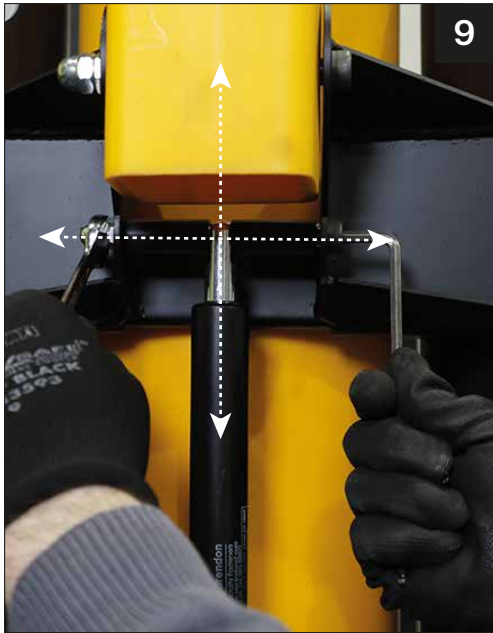

# J

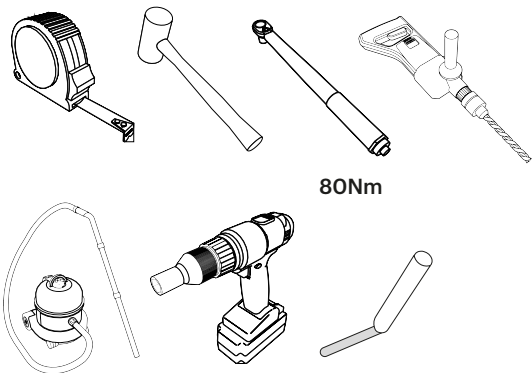

1 Ground Fixing x8



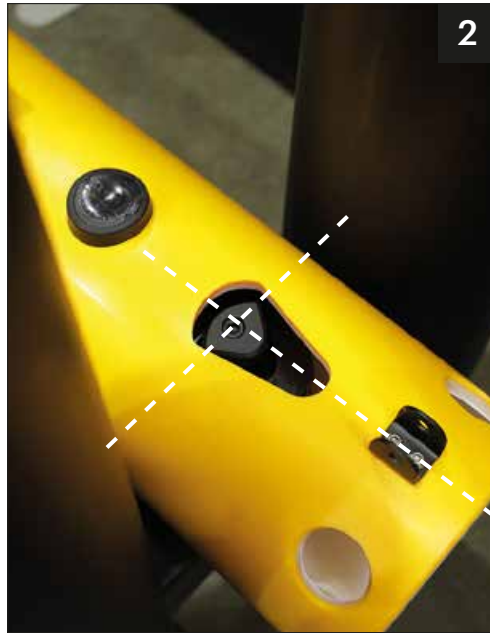
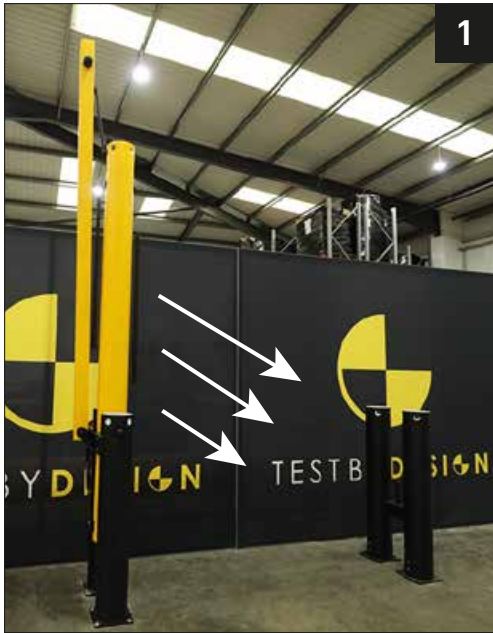



# K

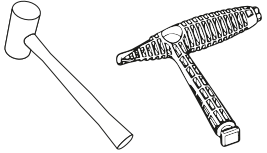

- 1 Lock Pin x24
- 2 Post Top and Rail End Caps x6
- 3 Pin plug x24

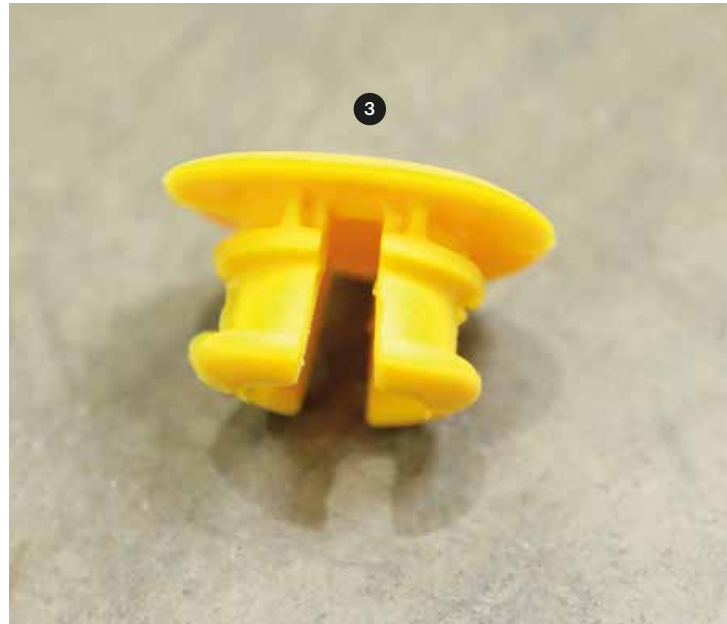

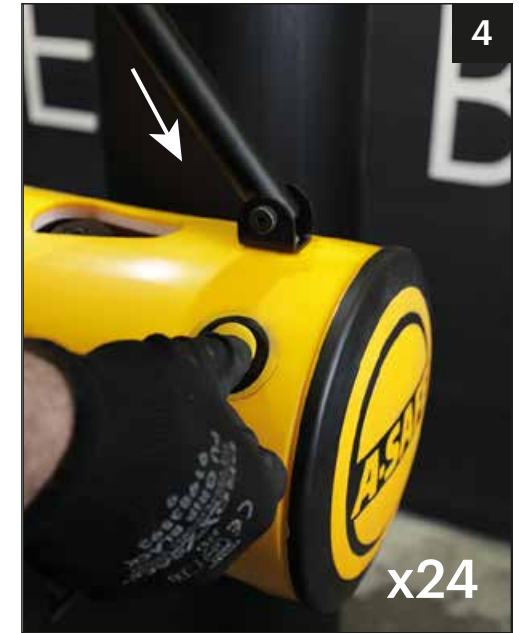

This document has been produced by the Product Management Team at A-SAFE HQ.

